



TECHNICAL SPECIFICATIONS



“ By the help of plug and connector’s special design, the body is mounted to the inserts by one screw from the side. ”

“ Special stepped designed cable entry provides ideal sealing for different diameter cables. ”

“ Angled design of the inserts provide easy application while angled plugs are used. ”

“ Protection covers are made of thermoplastic elastomer (TPE) material which have a long lasting lifetime ”



INSERTS

Material	PA6
Poles	2P+E
Electrical Data	16 - 25 - 32 A 250 - 415 V
Rated Current	16 - 25 - 32 A
Voltage	250 - 415 V
Impact Resistance	2 kV
Isolation Resistance	$\geq 5^{10} \Omega$
Flammability acc. to UL 94	V0
Mechanical Operating Life	≥ 10.000

CONTACTS

Material	Brass
Surface	Nickel Plate
Contact Resistance	$\leq 1 \text{ m} \Omega$
Connection Type	Screw Connection

HOUSINGS

Material	TPE
Protection Degree	IP44

General Features of Plugs



404001

- IP44 Protection Degree
- For Toughest Conditions
- Durable Rubber
- Double Earth System
- Easy To Use
- Solid Design
- Time Saving Easy Installation
- Wide Connection Range

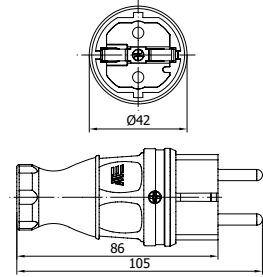

Plug Design



Maximum 3x2,5 mm² TTR cable should be used.

Plug Elements

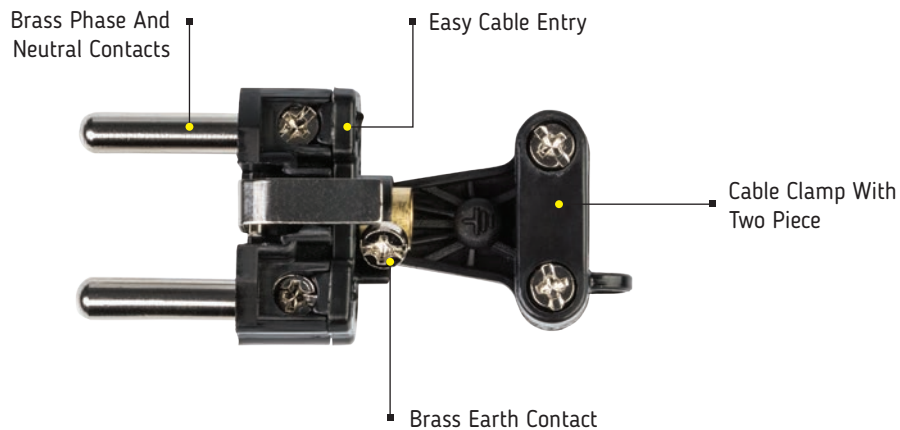

Sockets



404010

- IP44 Protection Degree
- For Toughest Conditions
- Durable Rubber
- Double Earth System
- Easy To Use
- Solid Design
- Time Saving Easy Installation
- Wide Connection Range

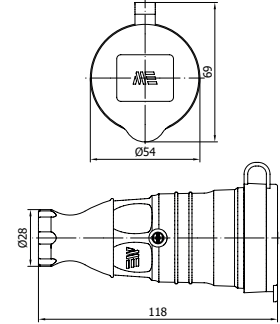

Socket Design



Maximum 3x2,5 mm² TTR cable should be used.

Socket Elements

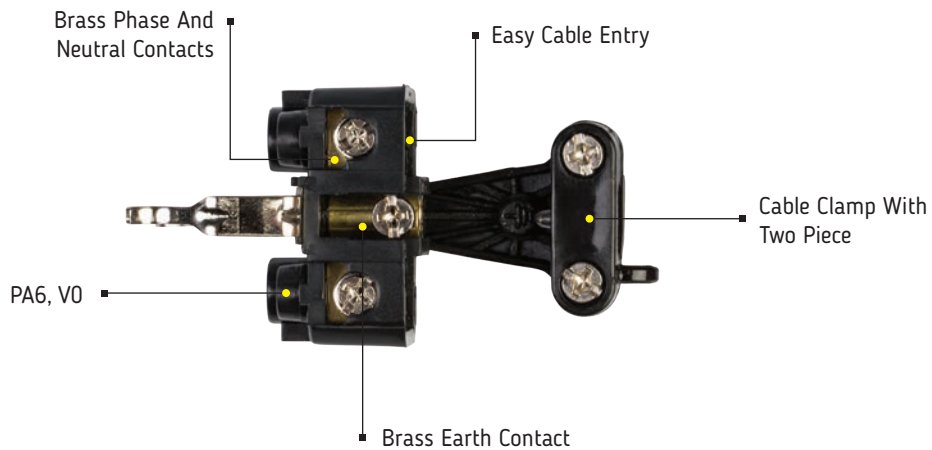



404002

RUBBER PLUG

Belgian / French

Number of Contacts	2P+E
Ampere	16
Protection Degree	IP44
Voltage	220 - 240 V
Terminal	Screw
Box Quantity	30

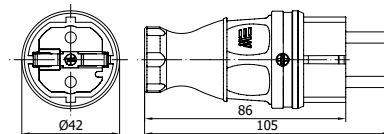

404004

RUBBER PLUG ANGLED

Belgian / French

Number of Contacts	2P+E
Ampere	16
Protection Degree	IP44
Voltage	220 - 240 V
Terminal	Screw
Box Quantity	30

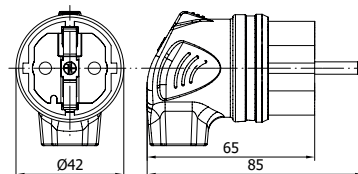

404011

RUBBER CONNECTOR

Belgian / French

Number of Contacts	2P+E
Ampere	16
Protection Degree	IP44
Voltage	220 - 240 V
Terminal	Screw
Box Quantity	20

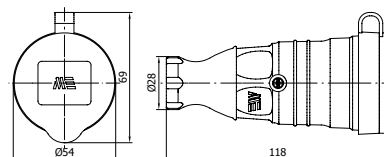

404013

RUBBER WALL SOCKET OUTLET

Belgian / French

Number of Contacts	2P+E
Ampere	16
Protection Degree	IP44
Voltage	220 - 240 V
Terminal	Screw
Box Quantity	20

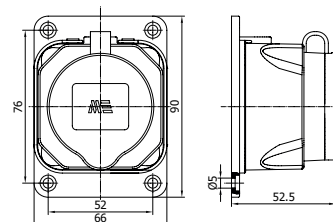



404049

RUBBER WALL SOCKET OUTLET ANGLED

Belgian / French

Number of Contacts	2P+E
Ampere	16
Protection Degree	IP44
Voltage	220 - 240 V
Terminal	Screw
Box Quantity	8

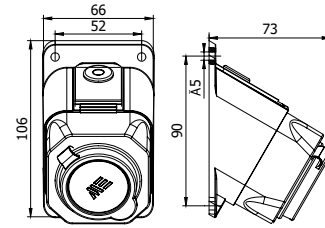

404006

RUBBER 2-WAY CONNECTOR

Belgian / French

Number of Contacts	2P+E
Ampere	16
Protection Degree	IP44
Voltage	220 - 240 V
Terminal	Screw
Box Quantity	10

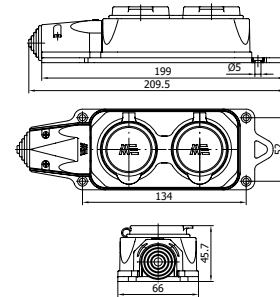

404015

RUBBER 3-WAY CONNECTOR

Belgian / French

Number of Contacts	2P+E
Ampere	16
Protection Degree	IP44
Voltage	220 - 240 V
Terminal	Screw
Box Quantity	6

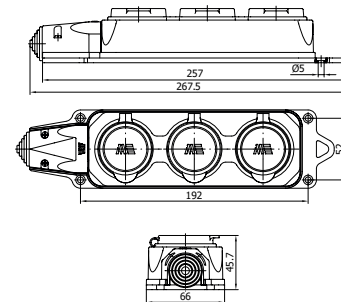

404008

RUBBER 4-WAY CONNECTOR

Belgian / French

Number of Contacts	2P+E
Ampere	16
Protection Degree	IP44
Voltage	220 - 240 V
Terminal	Screw
Box Quantity	6

